

SMITH-COOPER[®] INTERNATIONAL

CORPORATE OFFICE TEL (800) 766-0076 LOCAL (323) 890-4455 FAX (323) 890-4456
WWW.SMITHCOOPER.COM

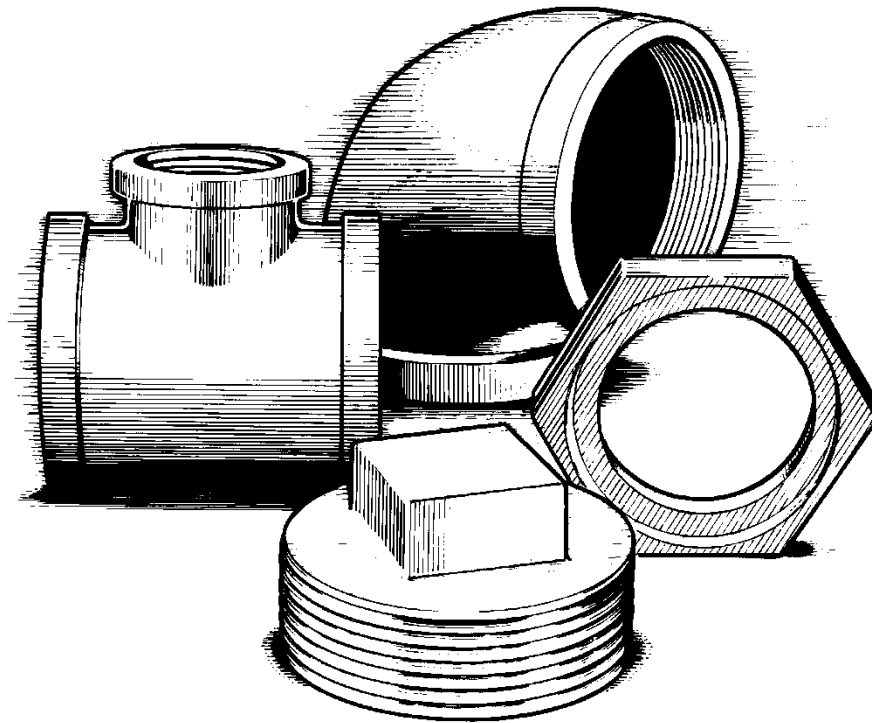

125# Bronze Fittings & 150# Bronze Flanges

PRICE SCHEDULE #BF0410

Effective April 2010
Subject to change without notice

NOT ALL BRONZE FITTINGS ARE CREATED EQUAL

The SCI Logo  on every fitting assures you:

Quality

Manufacturing facility is ISO 9001:2000

Over 50 years experience

Quality management inspections both at the overseas factory and our US warehouses

Reliability

SCI Bronze Fittings are true 85/5/5 Bronze, not Brass

Bronze Castings conform to ASTM B62

Bronze fitting dimensions conform to ASME B16.15

Bronze flange dimensions conform to ASME B16.24

Bronze Unions conform to WW-U-516B

NPT threads on all fittings and flanges conform to ASME B1.20.1

Fittings are 100% air tested

Independent lab verification that fittings meet applicable chemical & physical properties

Availability

SCI Fittings stocked throughout the USA

Stocked in sizes 1/8" to 4"

One of the largest inventories in the nation

Protection

USA on-staff engineer available at your request

\$10,000,000 product liability insurance

SCI trademark logo on each fitting

SCI 5/50 guarantee

Customer Service

Pro Pak System makes products easier to handle and warehouse

Near perfect fill rate

Same day shipment of orders

Fax confirmation of every order

Knowledgeable customer service personnel





SMITH-COOPER[®]
INTERNATIONAL





 Voice (323) 890-4455 (800) 766-0076

 Fax (323) 890-4456

Part Number	Size	Inner	Case	List Price	Part Number	Size	Inner	Case	List Price
90° Elbow Fig# 36E 					45° Elbow Fig# 36F 				
E 1001C	1/8	50	800	\$4.13	F 1001C	1/8	50	800	\$4.53
E 1002C	1/4	35	560	\$4.13	F 1002C	1/4	30	480	\$4.53
E 1003C	3/8	45	540	\$4.13	F 1003C	3/8	50	600	\$4.53
E 1004C	1/2	50	400	\$6.29	F 1004C	1/2	50	200	\$5.75
E 1006C	3/4	35	140	\$8.46	F 1006C	3/4	40	160	\$8.46
E 1010C	1	20	80	\$13.05	F 1010C	1	20	80	\$14.29
E 1012C	1-1/4	20	40	\$20.76	F 1012C	1-1/4	20	40	\$22.85
E 1014C	1-1/2	15	30	\$25.92	F 1014C	1-1/2	8	32	\$28.63
E 1020C	2	8	16	\$42.20	F 1020C	2	12	24	\$46.42
E 1024C	2-1/2	6	12	\$82.79	F 1024C	2-1/2	-	15	\$90.93
E 1030C	3	-	7	\$126.98	F 1030C	3	-	10	\$146.17
E 1040C	4	-	3	\$306.24	F 1040C	4	-	3	\$334.14

90° Reducing Elbow Fig# 36RE 				
RE1003001C	3/8x1/8	70	560	\$6.40
RE1003002C	3/8x1/4	60	480	\$6.40
RE1004001C	1/2x1/8	50	400	\$6.80
RE1004002C	1/2x1/4	50	400	\$6.80
RE1004003C	1/2x3/8	50	200	\$6.80
RE1006002C	3/4x1/4	50	200	\$9.26
RE1006003C	3/4x3/8	50	200	\$9.26
RE1006004C	3/4x1/2	50	200	\$9.26
RE1010004C	1x1/2	30	120	\$16.25
RE1010006C	1x3/4	30	120	\$16.25
RE1012004C	1-1/4x1/2	20	80	\$25.38
RE1012006C	1-1/4x3/4	15	60	\$25.38
RE1012010C	1-1/4x1	10	40	\$25.38
RE1014004C	1-1/2x1/2	15	60	\$32.06
RE1014006C	1-1/2x3/4	15	60	\$32.06
RE1014010C	1-1/2x1	10	40	\$32.06
RE1014012C	1-1/2x1-1/4	10	40	\$32.06
RE1020004C	2x1/2	15	60	\$59.16
RE1020006C	2x3/4	10	40	\$59.16
RE1020010C	2x1	14	28	\$59.16
RE1020012C	2x1-1/4	10	20	\$59.16
RE1020014C	2x1-1/2	10	20	\$59.16
RE1024010C	2-1/2x1	8	16	\$100.24
RE1024012C	2-1/2x1-1/4x	8	16	\$100.24
RE1024014C	2-1/2x1-1/2	8	16	\$100.24
RE1024020C	2-1/2x2	8	16	\$100.24
RE1030012C	3x1-1/4	5	10	\$160.11
RE1030014C	3x1-1/2	5	10	\$160.11
RE1030020C	3x2	-	8	\$160.11
RE1030024C	3x2-1/2	-	8	\$160.11
RE1040024C	4x2-1/2	-	5	\$362.33

90° Street Elbow Fig# 36SE 				
SE1001C	1/8	60	960	\$6.29
SE1002C	1/4	35	560	\$6.29
SE1003C	3/8	40	320	\$6.29
SE1004C	1/2	75	300	\$7.80
SE1006C	3/4	40	160	\$11.02
SE1010C	1	40	80	\$18.23
SE1012C	1-1/4	25	50	\$27.91
SE1014C	1-1/2	9	36	\$36.36
SE1020C	2	10	20	\$61.65
SE1024C	2-1/2	-	10	\$97.46
SE1030C	3	-	7	\$146.17
SE1040C	4	-	3	\$438.56

45° Street Elbow Fig# 36SF 				
SF1001C	1/8	70	1,120	\$6.40
SF1002C	1/4	40	640	\$6.40
SF1003C	3/8	50	600	\$6.40
SF1004C	1/2	75	300	\$7.80
SF1006C	3/4	40	160	\$11.02
SF1010C	1	25	100	\$18.23
SF1012C	1-1/4	10	40	\$27.91
SF1014C	1-1/2	10	40	\$37.48
SF1020C	2	12	24	\$63.53
SF1024C	2-1/2	5	10	\$128.46
SF1030C	3	-	6	\$256.93
SF1040C	4	-	4	\$513.85

Tees Fig# 33T 				
T 1001C	1/8	80	640	\$5.75
T 1002C	1/4	40	400	\$5.75
T 1003C	3/8	30	240	\$5.75
T 1004C	1/2	40	160	\$7.23
T 1006C	3/4	30	120	\$10.40
T 1010C	1	25	50	\$18.48
T 1012C	1-1/4	14	28	\$25.92
T 1014C	1-1/2	15	30	\$35.66
T 1020C	2	-	15	\$58.43
T 1024C	2-1/2	-	10	\$113.61
T 1030C	3	-	6	\$173.74
T 1040C	4	-	2	\$417.55

Threaded Bronze Pipe Fittings meet the following specifications: ASTM B62, ASME B16.15, ANSI/ASME B1.20.1

Part Number	Size	Inner	Case	List Price	Part Number	Size	Inner	Case	List Price
-------------	------	-------	------	------------	-------------	------	-------	------	------------

Reducing Tee					Fig# 36RT 				
RT1003001C	3/8x1/8	40	160	\$7.09					
RT1004001C	1/2x1/8	25	200	\$8.77					
RT1004002C	1/2x1/4	25	200	\$8.77					
RT1004003C	1/2x3/8	25	200	\$8.77					
RT1006002C	3/4x1/4	25	100	\$12.47					
RT1006003C	3/4x3/8	30	120	\$12.47					
RT1006004C	3/4x1/2	30	120	\$12.46					
RT1006004004C	3/4x1/2x1/2	30	120	\$13.70					
RT1006004006C	3/4x1/2x3/4	30	120	\$12.46					
RT1010002C	1x1/4	25	100	\$22.77					
RT1010003C	1x3/8	20	80	\$22.77					
RT1010004C	1x1/2	15	60	\$22.77					
RT1010004004C	1x1/2x1/2	20	80	\$24.82					
RT1010004006C	1x1/2x3/4	20	80	\$24.82					
RT1010004010C	1x1/2x1	15	60	\$24.82					
RT1010006C	1x3/4	15	60	\$22.77					
RT1010006004C	1x3/4x1/2	20	80	\$24.82					
RT1010006006C	1x3/4x3/4	15	60	\$24.82					
RT1010006010C	1x3/4x1	15	60	\$24.82					
RT1012004C	1-1/4x1/2	20	40	\$32.09					
RT1012004006C	1-1/4x1/2x3/4	25	50	\$34.82					
RT1012004010C	1-1/4x1/2x1	20	40	\$34.82					
RT1012006C	1-1/4x3/4	20	40	\$32.09					
RT1012010C	1-1/4x1	20	40	\$32.09					
RT1012010004C	1-1/4x1x1/2	20	40	\$34.82					
RT1012010006C	1-1/4x1x3/4	20	40	\$34.82					
RT1014004C	1-1/2x1/2	18	36	\$44.16					
RT1014004012C	1-1/2x1/2x1-1/4	15	30	\$55.80					
RT1014006C	1-1/2x3/4	15	30	\$44.20					
RT1014006006C	1-1/2x3/4x3/4	20	40	\$55.80					
RT1014010C	1-1/2x1	15	30	\$44.20					
RT1014010012C	1-1/2x1x1-1/4	15	30	\$55.80					
RT1014012C	1-1/2x1-1/4	15	30	\$44.20					
RT1014012004C	1-1/2x1-1/4x1/2	15	30	\$55.80					
RT1014012006C	1-1/2x1-1/4x3/4	15	30	\$55.80					
RT1014012010C	1-1/2x1-1/4x1	15	30	\$55.80					
RT1014012014C	1-1/2x1-1/4x1-1/2	15	30	\$55.80					
RT1020004C	2x1/2	12	24	\$72.17					
RT1020004004C	2x1/2x1/2	12	24	\$91.07					
RT1020006C	2x3/4	12	24	\$72.24					
RT1020006010C	2x3/4x1	12	24	\$72.17					
RT1020010C	2x1	12	24	\$72.17					
RT1020010012C	2x1x1-1/4	12	24	\$91.07					
RT1020010014C	2x1x1-1/2	12	24	\$91.07					
RT1020012C	2x1-1/4	10	20	\$72.17					
RT1020012004C	2x1-1/4x1/2	10	20	\$91.07					
RT1020012012C	2x1-1/4x1-1/4	10	20	\$91.07					
RT1020012014C	2x1-1/4x1-1/2	10	20	\$91.07					
RT1020012020C	2x1-1/4x2	8	16	\$91.07					
RT1020014C	2x1-1/2	8	16	\$72.17					
RT1020014010C	2x1-1/2x1	10	20	\$91.07					
RT1020014012C	2x1-1/2x1-1/4	8	16	\$91.07					
RT1024012C	2-1/2x1-1/4	-	10	\$139.34					
RT1024014C	2-1/2x1-1/2	-	10	\$139.34					
RT1024020C	2-1/2x2	-	10	\$139.21					
RT1030006C	3x3/4	-	6	\$215.79					
RT1030010C	3x1	-	6	\$215.79					
RT1030012C	3x1-1/4	-	6	\$215.79					
RT1030014C	3x1-1/2	-	6	\$215.79					
RT1030020C	3x2	-	6	\$215.79					
RT1030024C	3x2-1/2	-	6	\$215.79					

Reducing Tee, Contd.					Fig# 36RT 				
RT1040010C	4x1	-	4	\$501.09					
RT1040012C	4x1-1/4	-	4	\$501.09					
RT1040014C	4x1-1/2	-	4	\$501.09					
RT1040020C	4x2	-	3	\$501.09					
RT1040030C	4x3	-	3	\$501.09					



Bull Head Tee					Fig# 36BT 				
BT1004006C	1/2x3/4	25	100	\$12.56					
BT1006010C	3/4x1	20	80	\$23.14					
BT1010012C	1x1-1/4	15	60	\$32.62					
BT1010014C	1X1-1/2	8	16	\$44.57					

Cross					Fig# 36X 				
X 1001C	1/8	30	480	\$9.60					
X 1002C	1/4	20	240	\$9.60					
X 1003C	3/8	20	160	\$9.60					
X 1004C	1/2	40	160	\$11.67					
X 1006C	3/4	20	80	\$16.86					
X 1010C	1	30	60	\$26.73					
X 1012C	1-1/4	20	40	\$41.84					
X 1014C	1-1/2	15	30	\$53.46					
X 1020C	2	10	20	\$111.41					
X 1024C	2-1/2	-	10	\$208.75					
X 1030C	3	-	7	\$422.25					
X 1040C	4	-	4	\$844.51					

Floor Flange					Fig# 36FF 				
FF1002C	1/4	50	200	\$11.71					
FF1003C	3/8	50	200	\$11.71					
FF1004C	1/2	50	200	\$11.71					
FF1006C	3/4	40	160	\$16.00					
FF1010C	1	20	80	\$26.22					
FF1012C	1-1/4	15	60	\$29.96					
FF1014C	1-1/2	12	48	\$41.82					
FF1020C	2	8	32	\$55.73					

Cap					Fig# 36C 				
C 1001C	1/8	120	1,920	\$3.10					
C 1002C	1/4	80	1,280	\$3.10					
C 1003C	3/8	60	720	\$3.10					
C 1004C	1/2	75	600	\$4.13					
C 1006C	3/4	40	320	\$5.46					
C 1010C	1	35	280	\$8.55					
C 1012C	1-1/4	25	100	\$13.02					
C 1014C	1-1/2	25	100	\$17.57					
C 1020C	2	18	72	\$29.82					
C 1024C	2-1/2	20	40	\$56.80					
C 1030C	3	12	24	\$90.55					
C 1040C	4	6	12	\$174.08					



Threaded Bronze Pipe Fittings meet the following specifications: ASTM B62, ASME B16.15, ANSI/ASME B1.20.1



Part Number	Size	Inner	Case	List Price	Part Number	Size	Inner	Case	List Price
Coupling, Banded 					Hex Bushing 				
Fig# 36CP					Fig# 36HB				
CP1001C	1/8	70	1,120	\$4.13	HB1002001C	1/4x1/8	120	1,920	\$3.28
CP1002C	1/4	40	640	\$4.13	HB1003001C	3/8x1/8	75	1,200	\$3.28
CP1003C	3/8	50	600	\$4.13	HB1003002C	3/8x1/4	75	1,200	\$3.28
CP1004C	1/2	40	320	\$5.19	HB1004001C	1/2x1/8	100	800	\$3.91
CP1006C	3/4	50	200	\$6.85	HB1004002C	1/2x1/4	100	800	\$3.28
CP1010C	1	25	100	\$10.40	HB1004003C	1/2x3/8	100	800	\$3.28
CP1012C	1-1/4	20	80	\$16.25	HB1006001C	3/4x1/8	50	600	\$5.46
CP1014C	1-1/2	12	48	\$22.09	HB1006002C	3/4x1/4	50	600	\$5.46
CP1020C	2	12	24	\$36.36	HB1006003C	3/4x3/8	50	600	\$4.53
CP1024C	2-1/2	8	16	\$60.19	HB1006004C	3/4x1/2	50	600	\$4.53
CP1030C	3	-	16	\$83.52	HB1010002C	1x1/4	50	400	\$8.31
CP1040C	4	-	8	\$160.11	HB1010003C	1x3/8	50	400	\$8.31
					HB1010004C	1x1/2	50	400	\$6.85
					HB1010006C	1x3/4	50	400	\$6.85

Reducing Coupling 				
Fig# 36RC				
RC1002001C	1/4x1/8	50	800	\$4.43
RC1003001C	3/8x1/8	35	560	\$4.43
RC1003002C	3/8x1/4	30	480	\$4.43
RC1004001C	1/2x1/8	50	400	\$6.40
RC1004002C	1/2x1/4	50	400	\$5.53
RC1004003C	1/2x3/8	40	320	\$5.53
RC1006001C	3/4x1/8	35	280	\$9.14
RC1006002C	3/4x1/4	30	240	\$9.14
RC1006003C	3/4x3/8	50	200	\$8.23
RC1006004C	3/4x1/2	60	240	\$8.23
RC1010002C	1x1/4	45	180	\$15.43
RC1010003C	1x3/8	30	120	\$15.43
RC1010004C	1x1/2	30	120	\$13.69
RC1010006C	1x3/4	25	100	\$13.69
RC1012004C	1-1/4x1/2	25	100	\$26.22
RC1012006C	1-1/4x3/4	25	100	\$22.09
RC1012010C	1-1/4x1	15	60	\$22.09
RC1014004C	1-1/2x1/2	15	60	\$31.43
RC1014006C	1-1/2x3/4	15	60	\$31.43
RC1014010C	1-1/2x1	15	60	\$27.91
RC1014012C	1-1/2x1-1/4	12	48	\$27.91
RC1020004C	2x1/2	14	56	\$46.74
RC1020006C	2x3/4	14	56	\$46.74
RC1020010C	2x1	14	56	\$46.74
RC1020012C	2x1-1/4	14	28	\$41.48
RC1020014C	2x1-1/2	12	24	\$41.48
RC1024010C	2-1/2x1	-	25	\$90.58
RC1024012C	2-1/2x1-1/4	-	25	\$90.58
RC1024014C	2-1/2x1-1/2	-	25	\$73.47
RC1024020C	2-1/2x2	-	25	\$73.47
RC1030010C	3x1	-	20	\$107.23
RC1030012C	3x1-1/4	-	20	\$107.23
RC1030014C	3x1-1/2	-	20	\$107.23
RC1030020C	3x2	-	20	\$97.39
RC1030024C	3x2-1/2	-	15	\$97.39
RC1040020C	4x2	-	10	\$263.90
RC1040024C	4x2-1/2	-	10	\$208.75
RC1040030C	4x3	-	8	\$208.75

HB1010002C	1x1/4	50	400	\$8.31
HB1010003C	1x3/8	50	400	\$8.31
HB1010004C	1x1/2	50	400	\$6.85
HB1010006C	1x3/4	50	400	\$6.85
HB1012004C	1-1/4x1/2	30	120	\$14.08
HB1012006C	1-1/4x3/4	30	120	\$11.67
HB1012010C	1-1/4x1	30	120	\$11.67
HB1014002C	1-1/2x1/4	25	100	\$18.23
HB1014003C	1-1/2x3/8	25	100	\$18.23
HB1014004C	1-1/2x1/2	25	100	\$18.23
HB1014006C	1-1/2x3/4	25	100	\$18.23
HB1014010C	1-1/2x1	25	100	\$14.91
HB1014012C	1-1/2x1-1/4	25	100	\$14.91
HB1020004C	2x1/2	20	80	\$26.61
HB1020006C	2x3/4	20	80	\$26.61
HB1020010C	2x1	20	80	\$26.61
HB1020012C	2x1-1/4	20	80	\$22.09
HB1020014C	2x1-1/2	20	80	\$22.09
HB1024004C	2-1/2x1/2	15	60	\$54.80
HB1024006C	2-1/2x3/4	15	60	\$54.80
HB1024010C	2-1/2x1	15	60	\$54.80
HB1024012C	2-1/2x1-1/4	15	60	\$54.80
HB1024014C	2-1/2x1-1/2	15	60	\$44.17
HB1024020C	2-1/2x2	15	60	\$44.17
HB1030004C	3x1/2	12	48	\$86.84
HB1030006C	3x3/4	12	48	\$86.84
HB1030010C	3x1	12	48	\$86.84
HB1030012C	3x1-1/4	12	48	\$86.84
HB1030014C	3x1-1/2	12	48	\$86.84
HB1030020C	3x2	12	48	\$66.80
HB1030024C	3x2-1/2	12	48	\$66.80
HB1040014C	4x1-1/2	5	20	\$180.98
HB1040020C	4x2	5	20	\$180.98
HB1040024C	4x2-1/2	5	20	\$153.19
HB1040030C	4x3	5	20	\$153.19



Lock Nut 				
Fig# 36LN				
LN1002C	1/4	125	2,000	\$2.05
LN1003C	3/8	125	1,500	\$2.05
LN1004C	1/2	100	800	\$3.28
LN1006C	3/4	60	480	\$3.91
LN1010C	1	40	320	\$5.83
LN1012C	1-1/4	30	240	\$9.50
LN1014C	1-1/2	45	180	\$12.31
LN1020C	2	25	100	\$19.56
LN1024C	2-1/2	14	56	\$32.91

Part Number	Size	Inner	Case	List Price	Part Number	Size	Inner	Case	List Price
Plug, Square Head, Cored Fig# 36SC 					Plug, Square Countersunk Fig# 36CS 				
SC1004C	1/2	50	800	\$4.33	CS1004C	1/2	50	800	\$3.75
SC1006C	3/4	30	360	\$4.95	CS1006C	3/4	30	4800	\$4.27
SC1010C	1	20	240	\$6.53	CS1010C	1	20	320	\$8.04
SC1012C	1-1/4	40	160	\$9.71	CS1012C	1-1/4	40	320	\$13.36
SC1014C	1-1/2	30	120	\$12.38	CS1014C	1-1/2	30	240	\$20.09
SC1020C	2	20	80	\$19.54	CS1020C	2	20	160	\$31.72
SC1024C	2-1/2	16	64	\$33.44	CS1024C	2-1/2	16	64	\$72.52
SC1030C	3	16	32	\$53.46	CS1030C	3	16	32	\$98.43
SC1040C	4	8	16	\$104.42	CS1040C	4	8	16	\$167.68

Part Number	Size	Inner	Case	List Price	Part Number	Size	Inner	Case	List Price
Plug, Square Head, Solid Fig# 36SP 					Union, Brass Seat Fig# 36U 				
SS1001C	1/8	300	4800	\$2.74	U 1001C	1/8	30	480	\$14.66
SS1002C	1/4	150	2400	\$2.74	U 1002C	1/4	20	240	\$14.66
SS1003C	3/8	100	1600	\$2.74	U 1003C	3/8	20	160	\$14.66
SS1004C	1/2	50	800	\$5.19	U 1004C	1/2	40	160	\$15.93
SS1006C	3/4	30	360	\$6.78	U 1006C	3/4	40	80	\$22.09
SS1010C	1	20	240	\$11.54	U 1010C	1	30	60	\$29.26
SS1012C	1-1/4	40	120	\$20.80	U 1012C	1-1/4	20	40	\$42.85
SS1014C	1-1/2	30	60	\$27.03	U 1014C	1-1/2	15	30	\$50.58
SS1020C	2	20	60	\$42.85	U 1020C	2	10	20	\$77.85
SS1024C	2-1/2	16	64	\$88.29	U 1024C	2-1/2	-	10	\$153.19
SS1030C	3	16	32	\$142.04	U 1030C	3	-	7	\$236.67
SS1040C	4	8	16	\$267.15	U 1040C	4	-	4	\$522.03

Threaded Bronze Pipe Fittings meet the following specifications: ASTM B62, ASME B16.15, ANSI/ASME B1.20.1

150 lb Bronze Flanges

Part Number	Size	Inner	List Price	Part Number	Size	Inner	List Price
Threaded Flange Flat Face Fig# 16TH 				Blind Flange, Flat Face Fig# 16BL 			
TH1004	1/2	-	\$38.20	BL1004	1/2	-	\$83.52
TH1006	3/4	-	\$51.10	BL1006	3/4	-	\$104.13
TH1010	1	-	\$67.41	BL1010	1	-	\$147.44
TH1012	1-1/4	-	\$95.49	BL1012	1-1/4	-	\$187.91
TH1014	1-1/2	-	\$110.14	BL1014	1-1/2	-	\$235.40
TH1020	2	-	\$177.51	BL1020	2	-	\$379.73
TH1024	2-1/2	-	\$258.75	BL1024	2-1/2	-	\$553.51
TH1030	3	-	\$319.74	BL1030	3	-	\$716.41
TH1040	4	-	\$482.89	BL1040	4	-	\$976.57
TH1060	6	-	\$828.31	BL1060	6	-	\$1,987.03
Threaded Flange Reducing Flat Face Fig# 16RT 							
RT1020074	1/2	-	\$536.35				
RT1020090	3/4	-	\$702.00				
RT1030090	1	-	\$786.90				

Bronze Flanges meet the following specifications: ASTM B62, ASME B16.15, ANSI/ASME B1.20.1

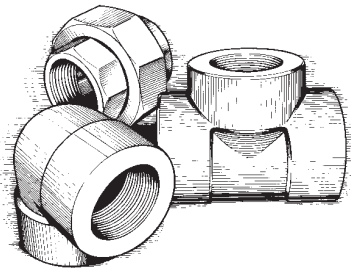

**Forged Steel
Fittings & Outlets**

1/8" - 4" Threaded & S/W
2000#, 3000#, 6000#

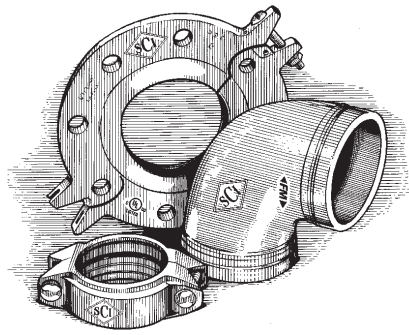

COOPLOK™ Grooved

UL/FM Couplings - Flexible & Rigid
Mechanical Tees, Fittings & Flanged Adapters

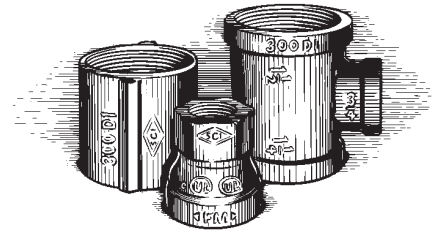

**Ductile Iron
Threaded Fittings**

1/2" - 2-1/2" Class 300
UL/FM @ 500 PSI

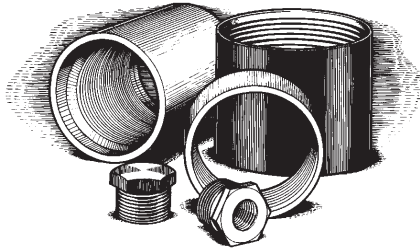

**Merchant Steel
Couplings & Fittings**

1/8" - 12" STD-XH
Full, Half, API Style

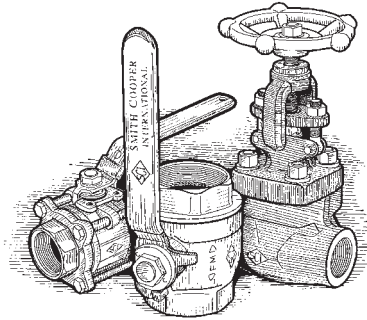

Valves

Carbon Steel - Stainless - Brass
1/4" - 4"

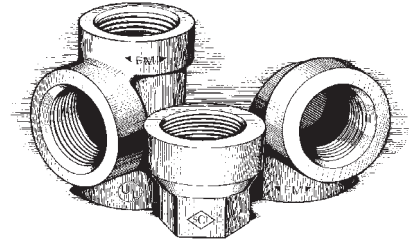

**Cast Iron
Threaded Fittings**

1/2" - 2-1/2" Class 125
UL/FM @ 300 PSI

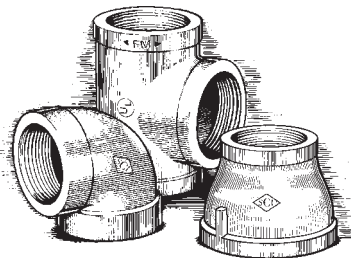

**Malleable Iron
Pipe Fittings**

1/8" - 8" Black & Galvanized
UL/FM 150# & 300#

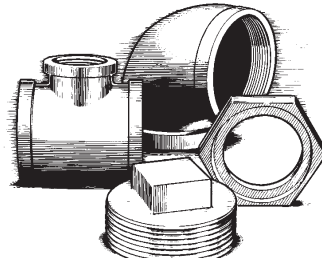

**Bronze Fittings & Flanges
Brass Nipples & Pipe**

1/8" - 6" 125#



**COOPLET® Weld Outlets
and Adapter Nipples**

UL/FM 300# Welded Outlets
Threaded 1/2" to 4", Grooved 1-1/4" to 4"

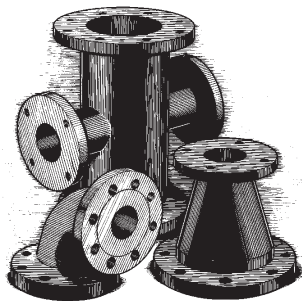

**Cast Iron Flanged
Fittings & Flanges**

Flanged Fittings 1" to 30", 125# & 250#
Cast Iron 125#, 250#, Flanges
Blind, Threaded, Reducing Threaded

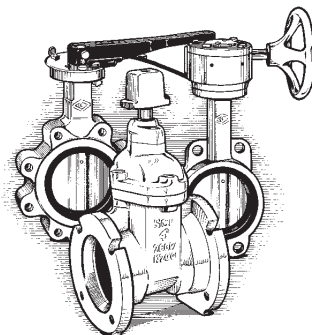

Butterfly & Gate Valves

Lug & Wafer Flanged, Mechanical
Joint, Threaded,
Push-On, Check

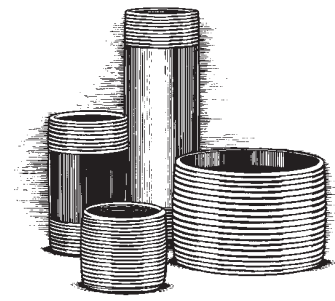

Nipples

1/8" - 8" Black & Galvanized
Welded - Seamless
Schedule 40, 80, & XXH, Brass Schedule 40

SMITH-COOPER®
INTERNATIONAL

2867 VAIL AVENUE, COMMERCE, CA 90040 TEL (800) 766-0076 LOCAL (323) 890-4455 FAX (323) 890-4456
WWW.SMITHCOOPER.COM